

Filter adapter for Keyence

Product image



Picture may differ from the original product

Description

- Adapter for mounting optical filters with filter thread M30,5x0,5 on Keyence code readers of SR1000 and SR2000 series

Technical data

Article No.	105.0022.01	105.0022.02
Title	Filter adapter SR1000 - M30,5x0,5	Filter adapter SR2000 - M30,5x0,5
Filter thread	M30,5x0,5	
Weight	13 g	17g
Material	Anodized aluminum	
Tariff code	94059900	
Country of Origin	Federal Republic of Germany	
Hints	-	Before mounting on the camera, the polarizing filter including socket must be removed

Technical drawing

Filter adapter SR1000 - M30,5x0,5 | Article No.: 105.022.01

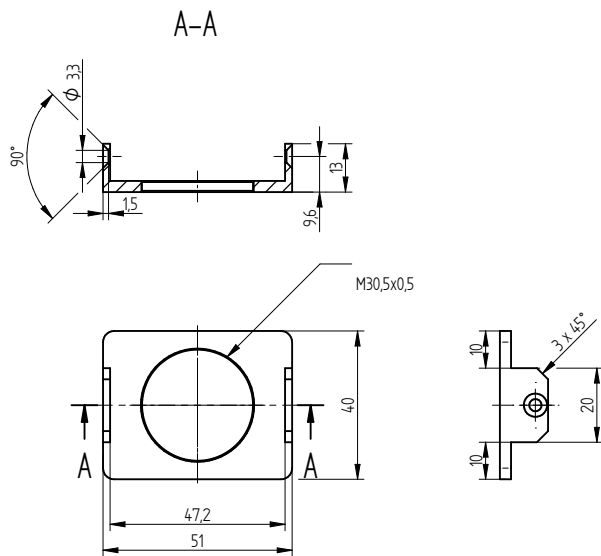

Filter adapter SR2000 - M30,5x0,5 | Article No.: 105.022.02

